



Spa Electrics®

LiTYARD[®] 2 **Wi-Fi**

Wi-Fi Outdoor Lighting Controller

OUTDOOR LIGHTING SYSTEM MANUAL

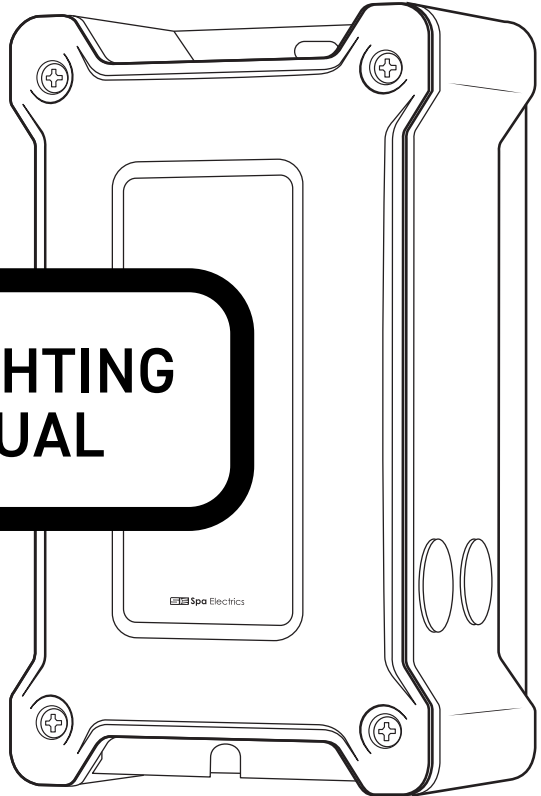

LiTYARD 2 Wi-Fi

INSTALLATION & OWNER'S MANUAL

CONTENTS

READ THIS FIRST	3
PRODUCT SUPPORT AND INFORMATION	3
WHAT'S INCLUDED	4
WIRING THE CONTROLLER	5
MOUNTING THE CONTROLLER	9
MOUNTING THE Wi-Fi HUB	10
APP INSTALLATION	13
APP SETUP	13
ADD A DEVICE	14
MULTI PLUS SETUP	18
OPERATING INSTRUCTIONS	20
TURNING LIGHTS ON	20
CHANGING SOLID COLORS	20
COLOR SHOWS	21
SCHEDULING	22
ZONES	24
WIRING EXAMPLES	26
APPENDIX / TROUBLESHOOTING / SPECIFICATIONS	28
FCC / ISED COMPLIANCE STATEMENT	29

READ THIS FIRST

Read and follow the safety instructions listed below and other basic safety precautions before installation or operation of this transformer and other associated equipment.

Light requirements

Ensure all of your lights are LiT YARD compatible before installation.

The LiT YARD system is compatible with Spa Electrics **MULTI PLUS** lights.

The LiT YARD system is not compatible with multi-color products or alternative lighting brands.

This power unit is specifically designed to supply 12V AC to landscape, fountain, swimming pool and spa luminaires.

Wi-Fi Network requirements

A local network providing internet connectivity via 2.4GHz Wi-Fi is required.

Installation must comply with provisions of the National Electrical Code, ANSI/NFPA 70, including those in Article 680 – Swimming Pools, Spas, Fountains and Water Features. Or the Canadian Electrical Code (CEC) CSA 22.1 as applicable, and all the local codes and ordinances.

CAUTION: for use only on a branch circuit protected by a Class A type ground fault circuit interrupter.

Power supplies are for outdoor use only. Not for use with an extension cord.

IMPORTANT NOTE



The diagrams and smart device images throughout this document are for illustrative purposes only, and may differ depending on your specific device and operating system (Android or Apple iOS).

WARNING



If the installation requires running wire through building structure, special wiring methods are needed.

Do not submerge.

Do not exceed the maximum ratings of individual components, wiring devices and current carrying capacity of conductors.

PRODUCT SUPPORT AND INFORMATION

VISIT: WWW.SPAELECTRICS.COM

WHAT'S INCLUDED



**LIT YARD 2
Controller**
(100 Watt
Transformer
enclosed)

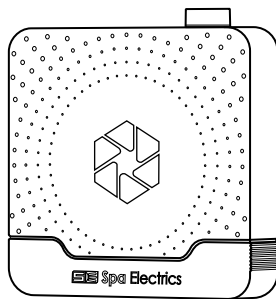

LIT YARD 2 Wi-Fi HUB

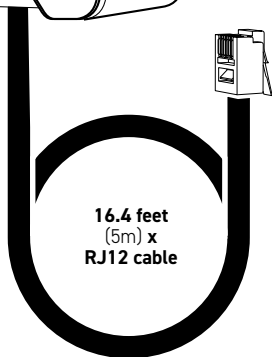

**16.4 feet
(5m) x
RJ12 cable**

WIRING THE CONTROLLER

RISK OF FIRE OR ELECTRIC SHOCK, DISCONNECT ELECTRIC POWER BEFORE SERVICING.



- IF INSTALLATION INVOLVES RUNNING WIRING THROUGH A STRUCTURE, SPECIAL WIRING METHODS ARE NEEDED.
- DO NOT CONNECT TWO OR MORE TRANSFORMERS/POWER SUPPLIES IN PARALLEL.

1 REMOVE THE LID

Open the LiT YARD 2 Controller to access wiring for 120V Input and 12/13V Output.

Remove the 4x Phillips Head screws to lift the lid off.

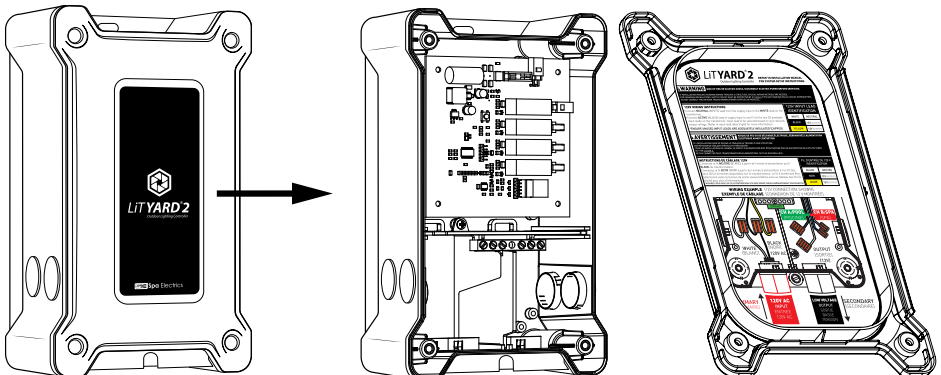
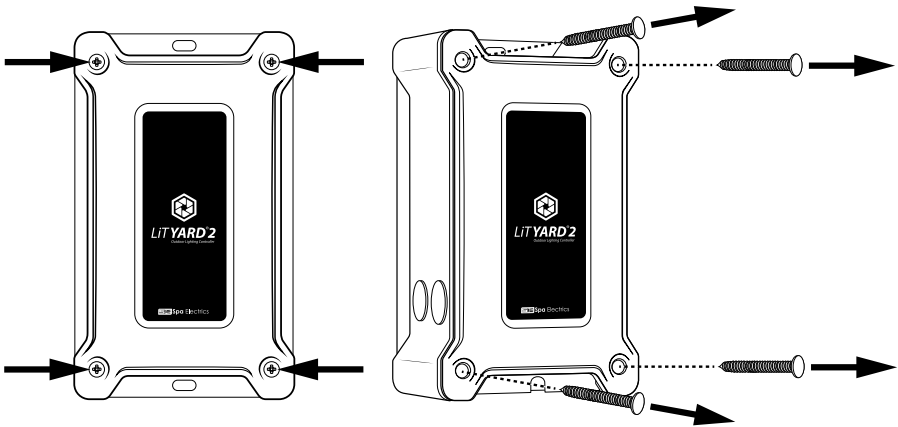

WIRING THE CONTROLLER ...CONTINUED

2 120V MAINS NEUTRAL CONNECTION

Connect the 'White' Neutral wire from the branch wire to the 'White' input lead of the transformer.

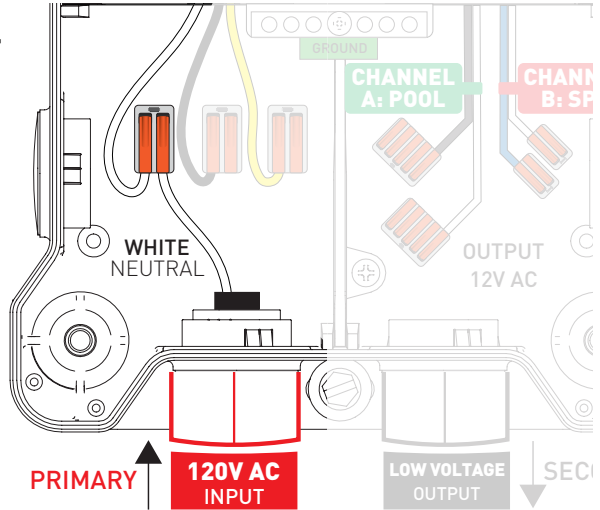



3 120V MAINS ACTIVE CONNECTION

IMPORTANT

The LiT YARD 2 Controller can be configured to output either 12V AC OR 13.5V AC

Connect the 'Black' 120V Active (Hot) wire to ONE (1) of the Active Input Leads:

 Black Input Lead = 12V Output

 Yellow Input Lead = 13.5V Output

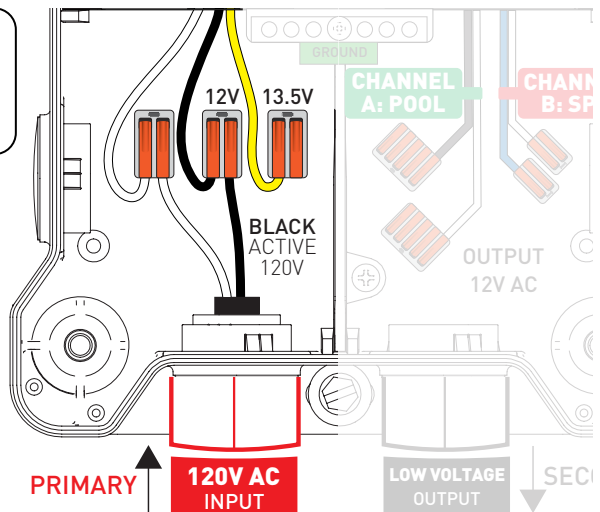

12V CONFIGURATION SHOWN

WIRING THE CONTROLLER ...CONTINUED

NOTE



Ensure the unused input lead remains adequately insulated (capped).

DO NOT CONNECT UNUSED ACTIVE INPUT TO GROUND.

4 GROUNDING CONNECTION

IMPORTANT

The LiT YARD 2 Controller does NOT require grounding. A grounding bar is provided in branch wired configurations for convenience only.

Connect ground wire from supply input to grounding bar.

Use remaining positions to connect any additional ground wires. Ensuring no wiring passes between primary and secondary compartments.

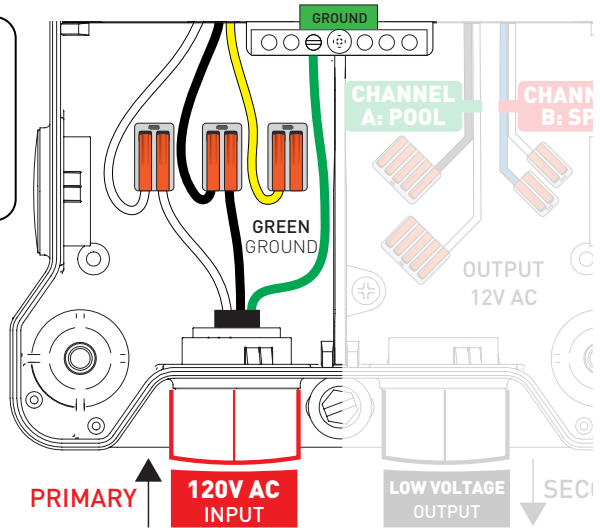

WIRING THE CONTROLLER ...CONTINUED

5 CONNECTING LIGHTS

Connect Spa Electrics Multi Plus lights on the Low Voltage Output (Secondary) side of the transformer.

There are two (2) separate channels that Lights can be connected to. These channels can be controlled independently in the app as 'Zones'.

In a typical pool & spa layout, it is common to connect the lights in the pool to Channel A. Then connect the Spa light to Channel B.

In the example below, one (1) pool light has been connected to Channel A and one (1) spa light has been connected to channel B

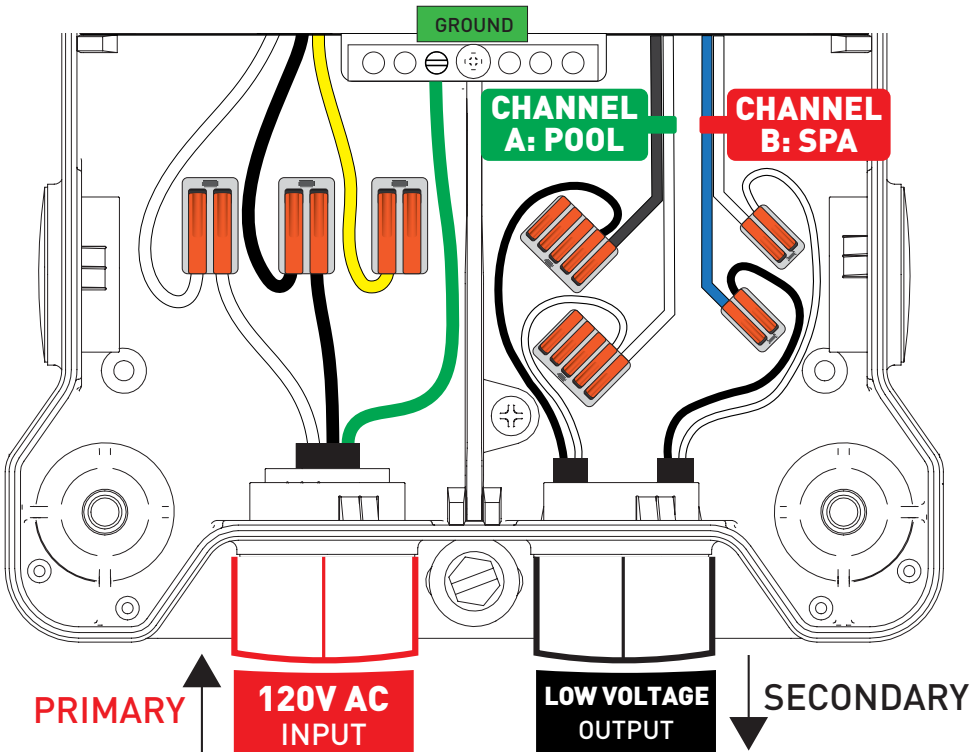

ENSURE THE LID OF THE CONTROLLER IS CLOSED AND SECURED WITH THE SAME 4x PHILLIPS HEAD SCREWS ONCE WIRING IS COMPLETE.

MOUNTING THE CONTROLLER

Positioning

Ensure the LiT YARD 2 Controller is vertically wall mounted at least 20" (500mm) above ground and in a serviceable location.

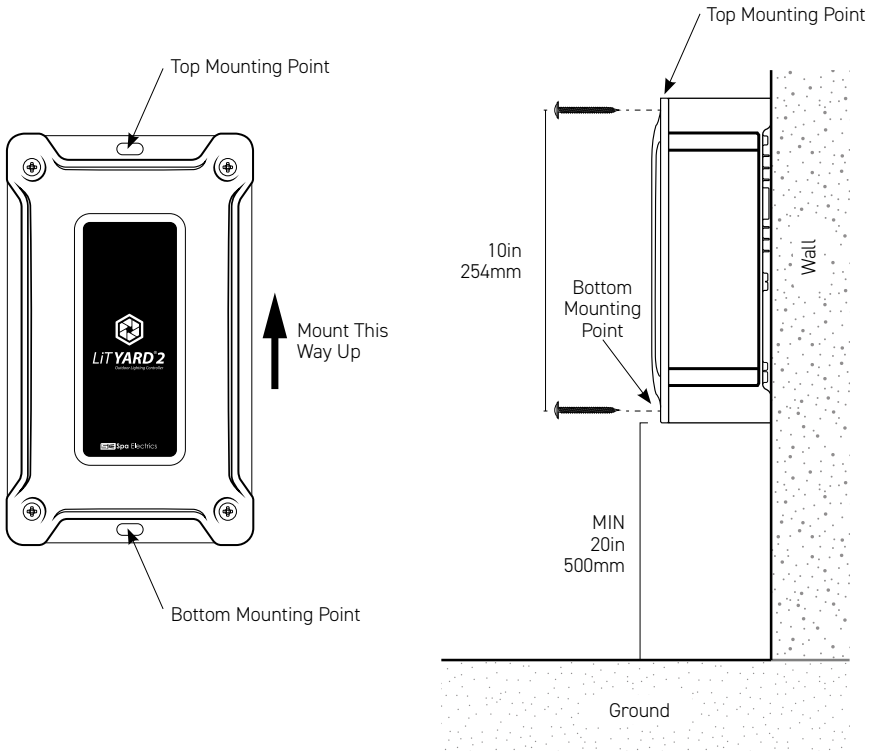

Screw kit included for LiT YARD 2



NOTE



This product has been designed for use with PVC/Flexible conduit, it is not intended to be used with metallic conduit. Connections/hubs need to be UL Listed, weather/rain-tight and suitable for the application. All conduits should be adequately supported to prevent excessive stress on the enclosure.

MOUNTING THE Wi-Fi HUB

Positioning

When finding a location to mount the LiT YARD 2 Wi-Fi HUB, there are some factors that will improve the connectivity of your Wi-Fi HUB to your Wi-Fi network/ Access Point.

The Wi-Fi HUB should be mounted:

- ✓ In an elevated position
- ✓ Vertically on a wall with the cable exiting on the bottom
- ✓ Outside of enclosures. eg. Pump houses or garden sheds
- ✓ In an area protected from the weather

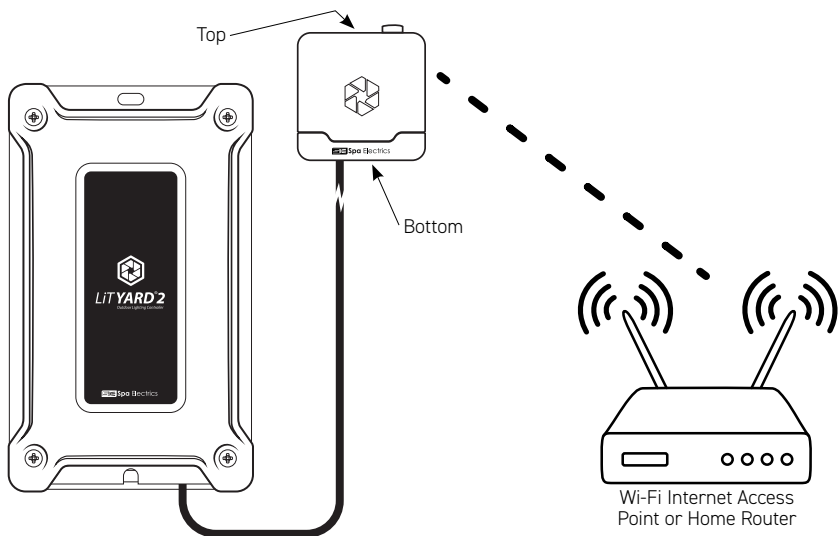

Minimizing the number of obstructions between the Wi-Fi HUB and your Wi-Fi internet access point will improve the connectivity between the devices. Materials such as tin, steel and concrete can have a detrimental affect on the Wi-Fi HUB signal.

NOTE: Wi-Fi Internet Access Point or Home Router not included.

1 INSTALLING THE KEYHOLE SCREW

The Wi-Fi HUB uses a keyhole hook arrangement for mounting. Fasten the screw into the wall material until the screw has 1/4-1/2 inches (7-11mm) still exposed from the wall.



MOUNTING THE Wi-Fi HUB ...CONTINUED

2 ATTACHING Wi-Fi HUB TO KEY HOLE SCREW

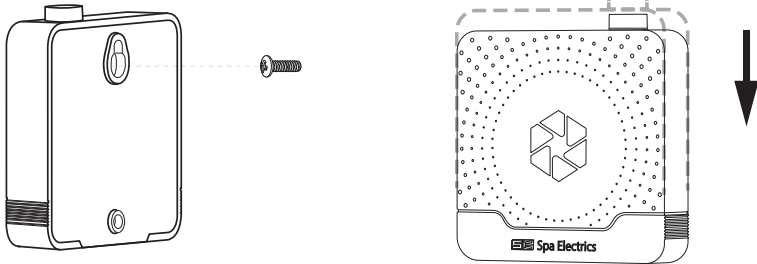

- 1: Slide the Wi-Fi HUB over the Mounting Screw using the Keyhole on the rear of the unit.
- 2: Lower the Wi-Fi HUB over the Mounting Screw to engage the locking portion of the Keyhole.

3 INSTALLING THE LOWER MOUNTING SCREW

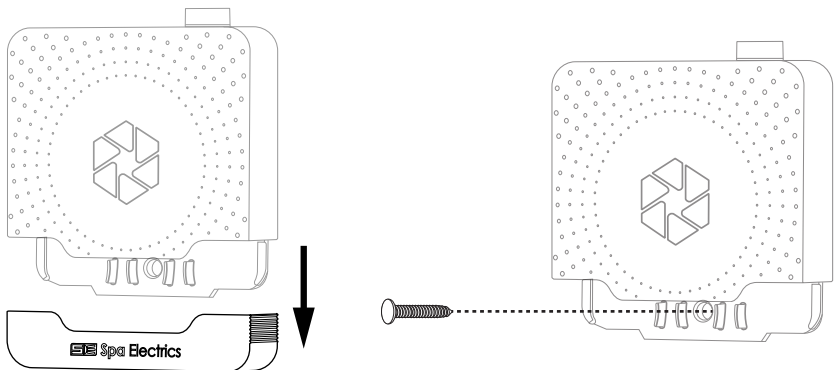

- 1: Remove the Lower Cover on the Wi-Fi HUB to expose the lower mounting hole.
- 2: Fasten a screw through the lower mounting hole into the wall material.

NOTE



When mounting the Wi-Fi HUB to concrete or brick, it is advised to first use the Wi-Fi HUB to mark the mounting hole position and remove the Wi-Fi HUB before drilling the pilot hole.

MOUNTING THE Wi-Fi HUB ...CONTINUED

4 CONNECTING Wi-Fi HUB

- 1: Remove the Cover and Insert the RJ12 cable into the Wi-Fi HUB.

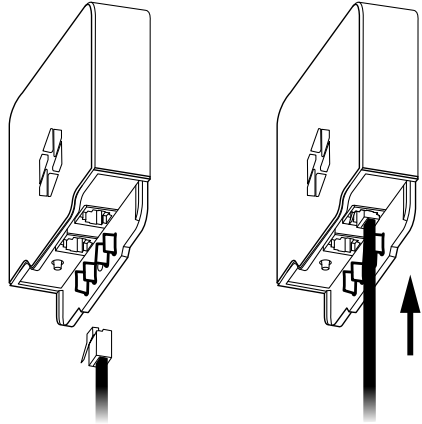

- 2: Insert the RJ12 cable into the Cable Guide Slot on the Lower Cover of the Wi-Fi HUB.

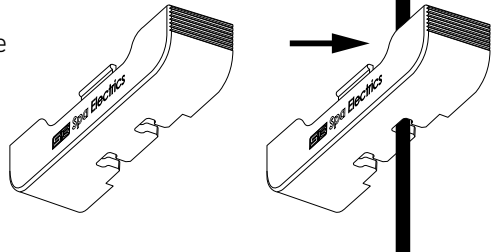

- 3: Leave the Lower Cover off during the app setup process.

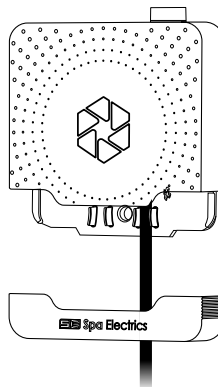

APP INSTALLATION

1. Go to your smart devices app store; Google Play (Android) or App Store (Apple iOS).
2. Search for "Smart Life - Smart Living".
3. Select to install the Smart Life app.

**SCAN FOR APP STORE
LINKS & MORE**

[spaelectrics.com/
lityard2-wifi-guides-landing](https://spaelectrics.com/lityard2-wifi-guides-landing)



APP SETUP

1. Open the Smart Life app.
2. Read the terms and conditions and then tap "Agree" to proceed.
3. You may be notified to allow notifications from the Smart Life app. Follow the prompts of your specific device to either allow or don't allow according to your preference.
4. Tap "Sign Up" to create a new smart life account.
Or tap "Log In" if you want to use an existing account.
Or optionally you can tap "Try as Guest" to use the app without creating an account. (see Appendix 1).
Proceed with your choice by following the on screen prompts.

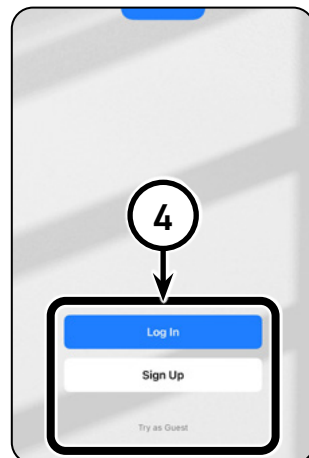
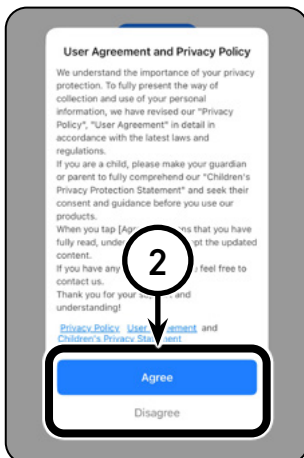

ADD A DEVICE

1. Tap the plus + button in the top right corner.
2. Tap "Add Device".
3. You may be prompted that the Smart Life app requires access permissions to Bluetooth and Location. If prompted, Tap "Continue".

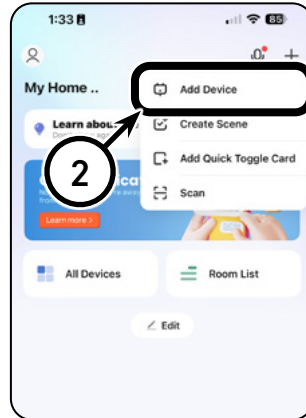
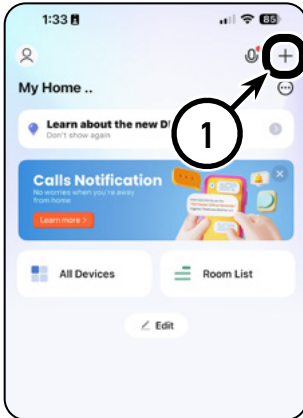

4. Then follow the prompts of your specific device to allow and enable Location and Bluetooth access.
5. Your specific device may prompt you to allow Smart Life to find nearby devices. Follow the prompts on your device to allow this function.

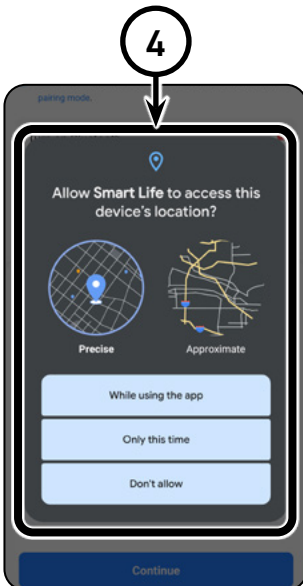

ADD A DEVICE ...CONTINUED

6. Ensure Bluetooth is enabled on your device.
7. Locate the Pairing Button on the bottom of the Wi-Fi HUB.
8. Press and hold the pairing button for *at least 5 seconds*. After holding for *at least 5 seconds*, release the button, the Status Light next to the pairing button should now be **Flashing**.

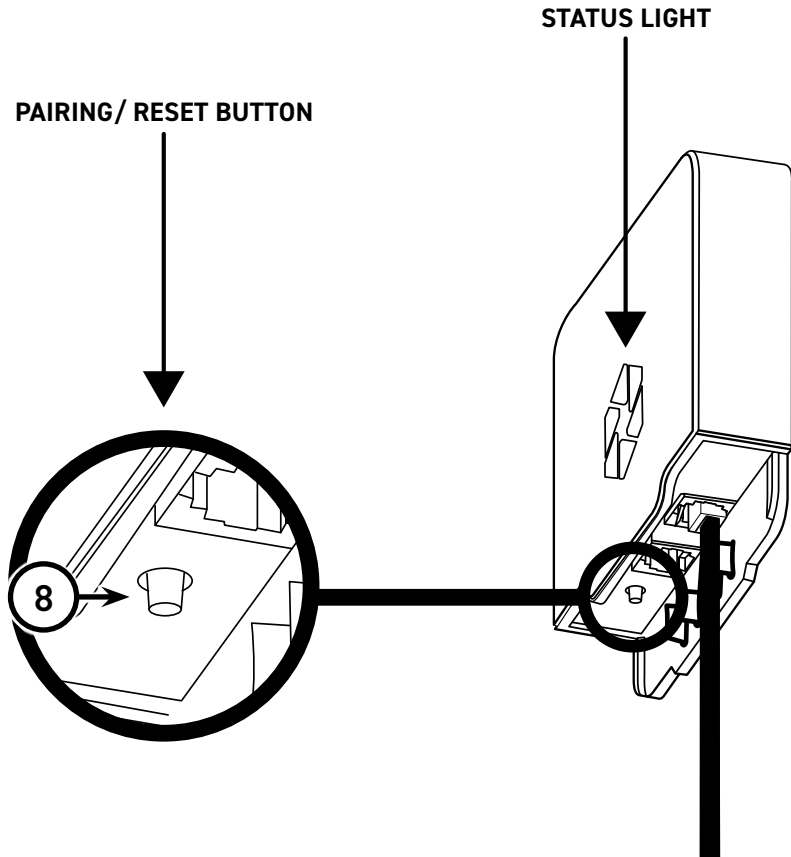

ADD A DEVICE ...CONTINUED

IMPORTANT



Ensure that the Status Light is flashing before proceeding to Step 9.

The device will **NOT** pair successfully otherwise.

If the status light is **NOT** flashing, repeat Step 8.

- Now that the status light on the Wi-Fi HUB is flashing, wait for the Add button to appear with the text "Discovering Devices". Then Tap "Add".
If the "Discovering Devices" prompt does not come up. Check that Bluetooth is turned on. Alternatively you can manually add the LiT YARD 2 Wi-Fi by tapping the "Socket Wi-Fi" option indicated below (**see fig. 9a**) and following the on screen prompts.
- Enter the Network ID and Password of the Wi-Fi network you want your LiT YARD 2 Wi-Fi to connect to. The smart device you are using must be connected to the same Wi-Fi network as the LiTYARD 2 Wi-Fi during this initial setup. If you are experiencing difficulties, try disabling Mobile Data.
- Then Tap "Next".

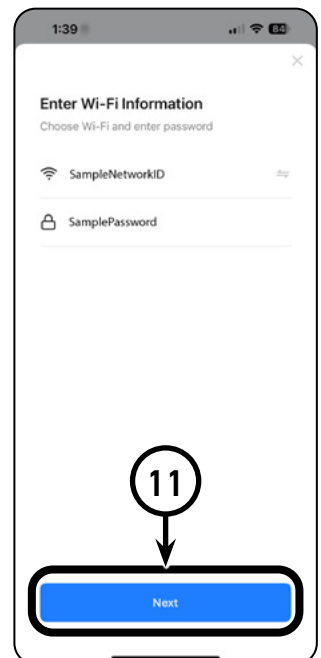
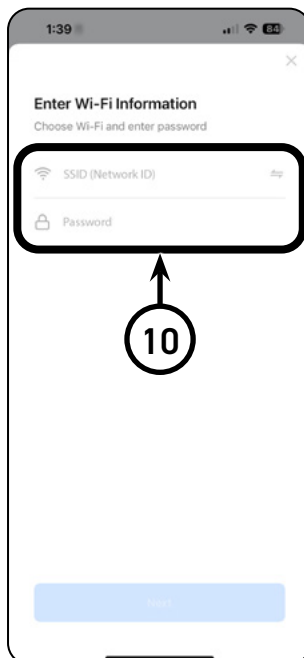
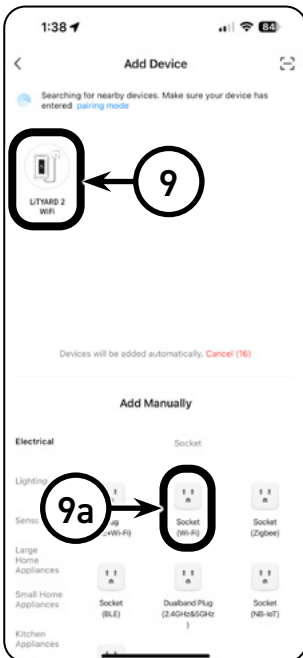

ADD A DEVICE ...CONTINUED

12. Wait for the LiT YARD 2 Wi-Fi to be added.
13. Once the LiT YARD 2 Wi-Fi has successfully been added, indicated by a green tick, Tap "Done".
14. You will then automatically be taken to the LiT YARD 2 Wi-Fi application. To use your LiT YARD 2 Wi-Fi, please tick the checkbox to confirm you have read and accepted the terms and conditions.
15. Then Tap "Confirm".

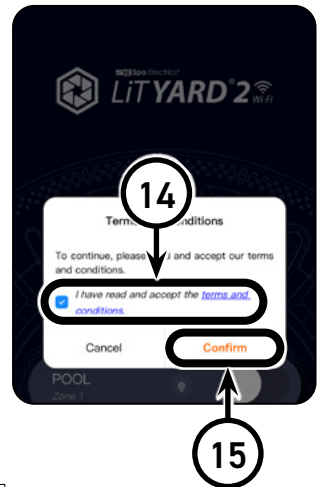
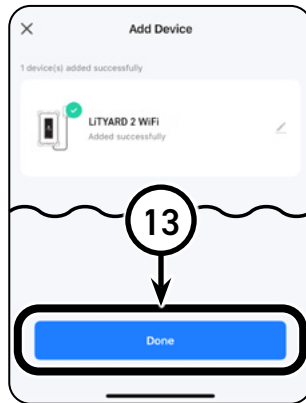
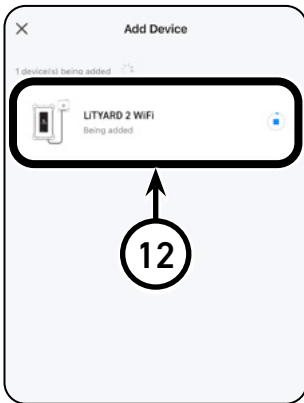

16. Re-Install the lower cover on the Wi-Fi HUB.

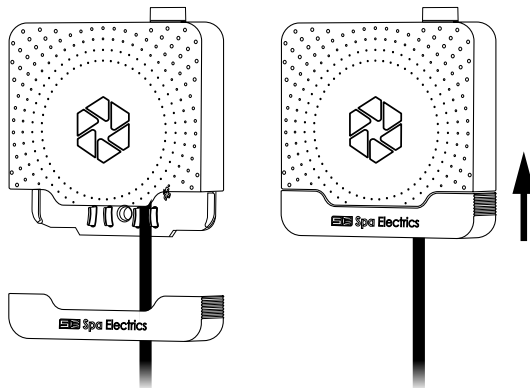

Your LiT YARD 2 Wi-Fi is now Successfully setup and ready for use.

Note: If the colors selected in the app do not match the color of the lights, go to Multi Plus Setup section of this instruction manual and follow the steps to put the lights into Spa Electrics LiT YARD 2 Controller mode.

MULTI PLUS SETUP

BEFORE YOU START

The following setup instructions are only required if the lights are not changing to the correct colors based on the colors selected in the app.

LiT YARD 2 Wi-Fi is compatible with Spa Electrics MULTI PLUS lights only.

The MULTIPLUS light has 9 inbuilt modes of operation for use on a variety of different control systems or installation types.

When you first install your MULTIPLUS light it will operate in the default, 'Manual' mode for use with a wall switch. In order to connect the light to Spa Electrics LiT YARD 2 Controller mode, please follow the below steps.

LiT YARD 2 Wi-Fi CONTROLLER QUICK SETUP

1. Tap Configuration to enter the Configuration menu.
2. Tap Support to enter the Support menu.

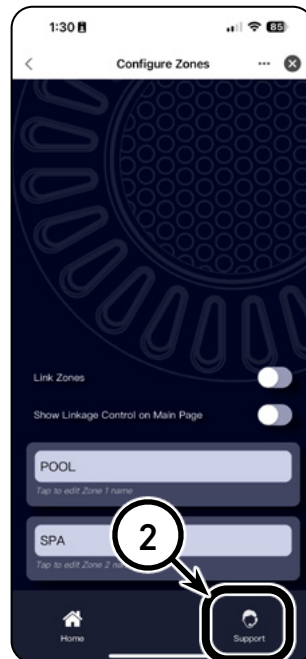
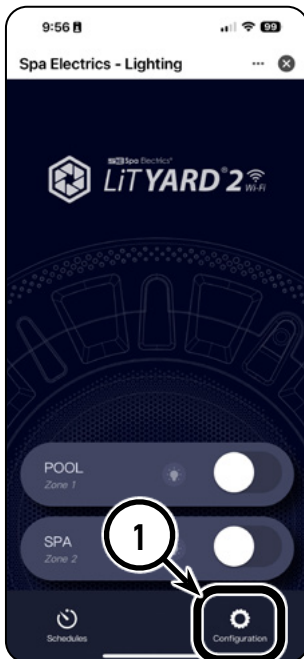

MULTI PLUS SETUP ...CONTINUED

3. Tap and Hold Service to enter the Service menu.
4. Double Tap "Set all lights to LiT YARD 2 Mode".
5. Tap "Confirm".

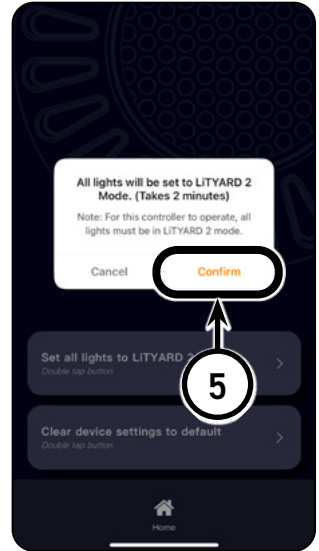
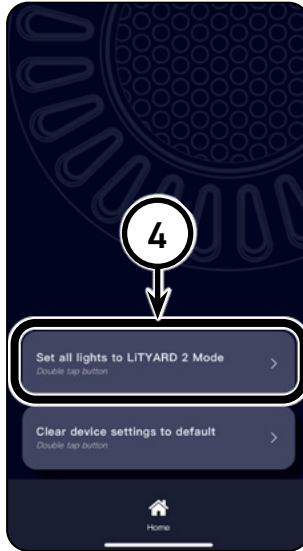
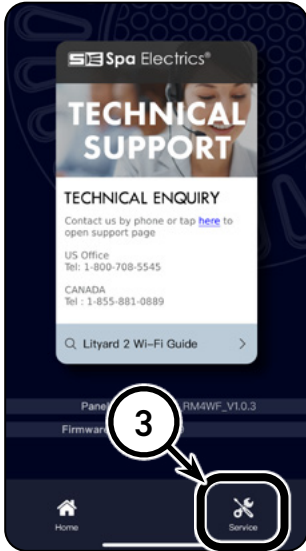

6. The lights will now automatically be setup into LiT YARD 2 Controller mode. Wait on this screen until the flashing 'please wait' message disappears. This will take approximately 2 minutes.



Your lights should now be in LiT YARD 2 Controller mode and ready for use.

Note: Confirm your lights operate correctly by selecting colors in the app and confirming the correct colors are output from the lights.

OPERATING INSTRUCTIONS

TURNING LIGHTS ON

1. Tap the LiT YARD 2 Wi-Fi shortcut on the Smart Life App home screen to enter the LiT YARD 2 Wi-Fi Application. Alternatively, Tap "All Devices" and select LiT YARD 2 Wi-Fi from your list of devices.
2. Tap the On/Off toggle of either Zone 1 or Zone 2, to turn the lights of that zone on.

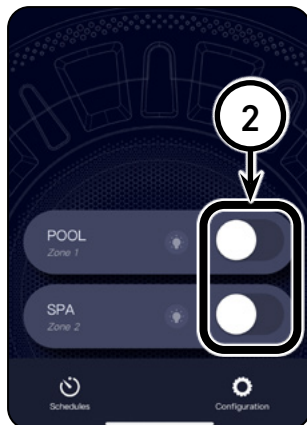
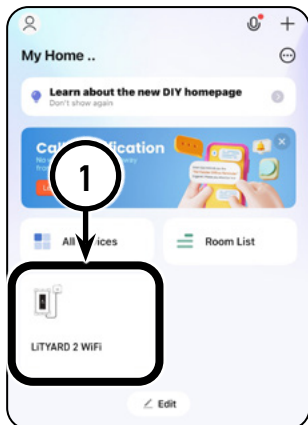

CHANGING SOLID COLORS

1. Tap the light bulb symbol on either Zone 1 or Zone 2, to turn the lights On and go to the color change menu.
2. Tap one of the color options on the screen to change the output color of the lights connected to the zone.

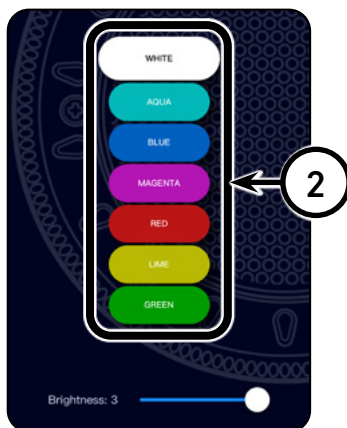
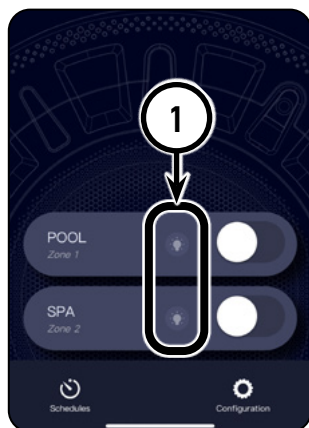

CHANGING SOLID COLORS ...CONTINUED

3. The brightness of the color can be changed from 1 (dimpest) to 3 (brightest) by moving the slider.

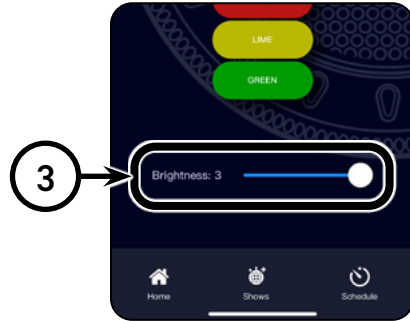

COLOR SHOWS

1. Tap the Show button to go to the Color Shows menu.
2. Tap one of the four Color Shows to change the output of the lights connected to the zone.
3. The speed of the Color Show can be changed from 1 (slowest) to 3 (fastest) by moving the slider.
4. The brightness of the Color show can be changed from 1 (dimpest) to 3 (brightest) by moving the slider.
5. If your lights appear to be out of sync with each other, Tap the "Sync" button to resynchronise the lights.

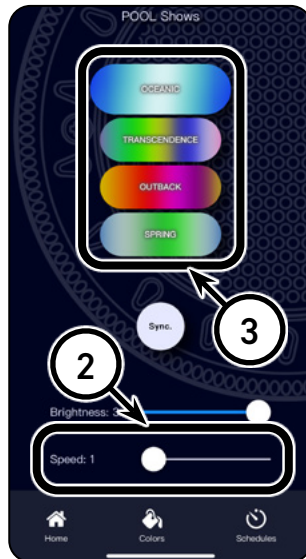
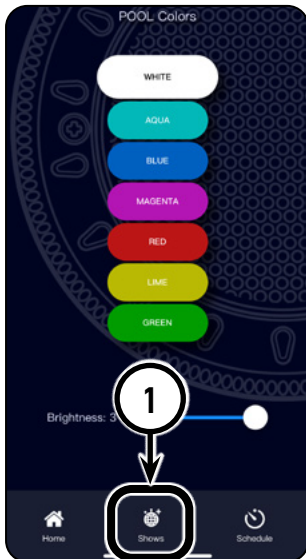

SCHEDULING

1. Tap the Schedules button to go to the Schedules menu.
2. Tap the On/Off toggle to enable Schedules.
3. Tap either Zone 1 or Zone 2, to view the list of schedules and to Add/Edit/Remove schedules for that Zone.

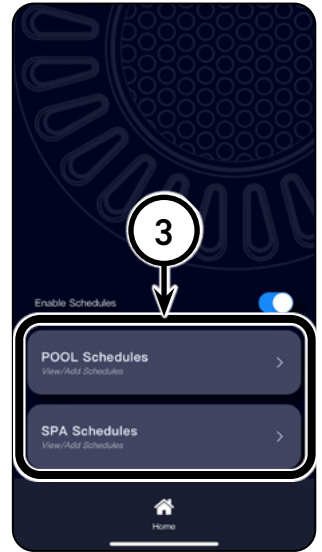
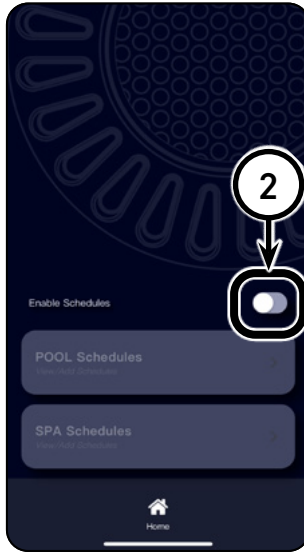
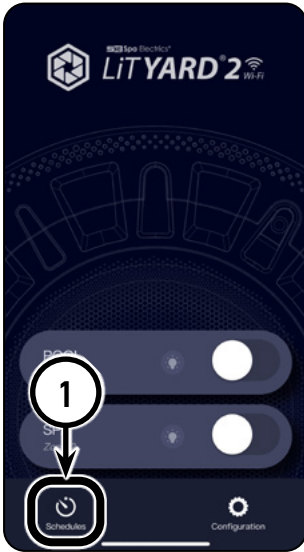

4. Tap the "Add" button to add a new schedule.

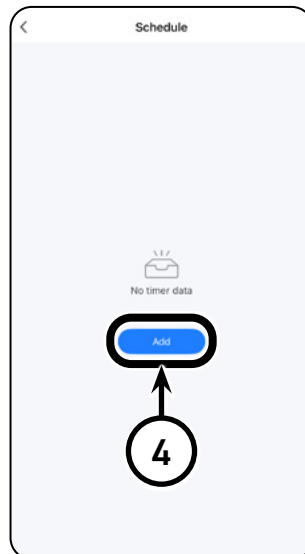

SCHEDULING ...CONTINUED

5. Set the start time for the schedule.
6. Set the days of the week the schedule will repeat.
7. Add a note for this schedule (optional).
8. Tap the On/Off toggle to receive a notification when the schedule is activated.
9. Set the duration in hours and minutes for the schedule. (This is the length of time the lights will be on from the start time before turning off).
10. Set the Color/Show and the Brightness (1 dimmest to 3 brightest). Also if selecting a Show, the speed can be set (1 slowest to 3 fastest).
11. After entering all the details of the schedule, Tap "Save".
12. When viewing the list of schedules, you can Tap a schedule to edit them.
13. Tapping the On/Off toggle on a schedule will enable/disable it.

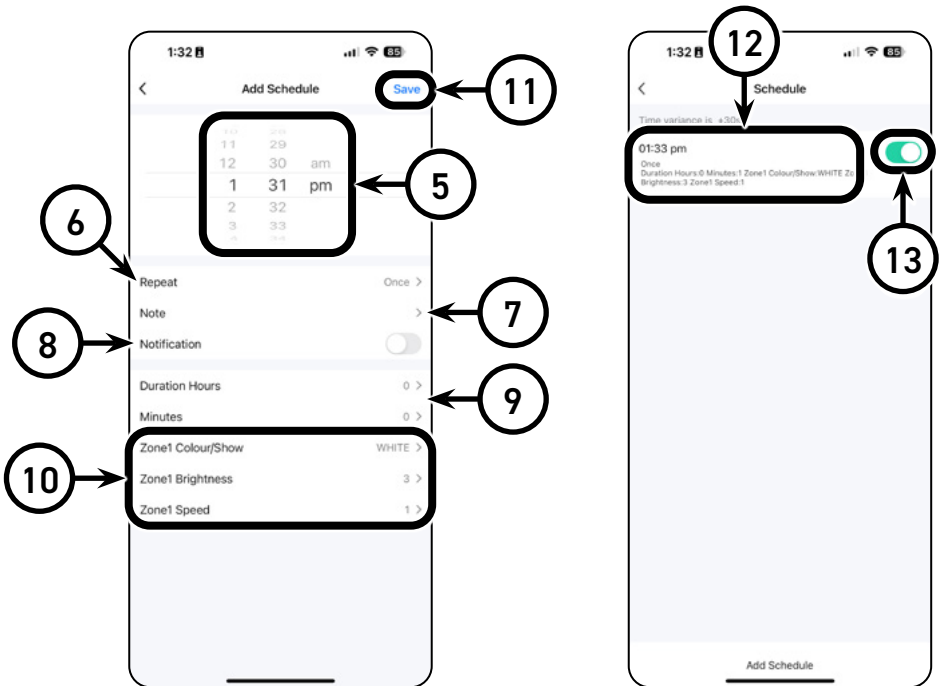

ZONES

The LiT YARD 2 Wi-Fi has two separate outputs (Channel A & Channel B) which correspond to two separate Zones within the app.

These Zones can be operated independently and can, as an example, be used to operate swimming pool lights separately to spa lights.

LINKING ZONES

Zones can be linked so that Solid Colors/ Color Shows/ Schedules selected in Zone 1 are automatically duplicated in Zone 2.

1. Tap Configuration to enter the Configuration menu.
2. Tap the "Link Zones" toggle button to link Zone 1 and Zone 2.

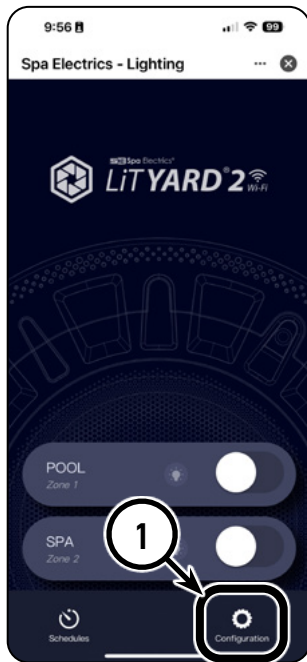

RENAMING ZONES

1. Tap on one of the Zone names.
2. Enter the new name of the Zone.
3. Tap "done" to save the new name. (The appearance of the "done" button on keyboards may vary between devices. On Android devices it may appear as an arrow pointing right, a tick symbol, or "Go".)

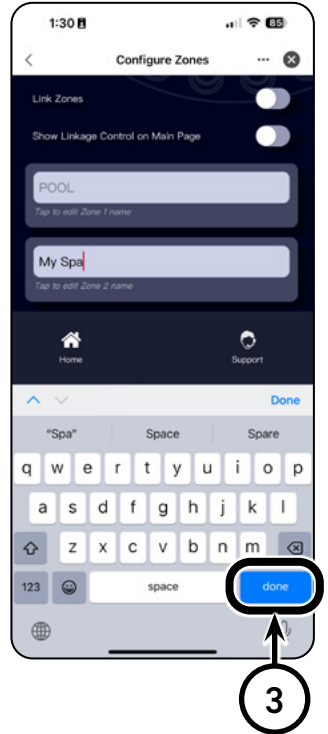
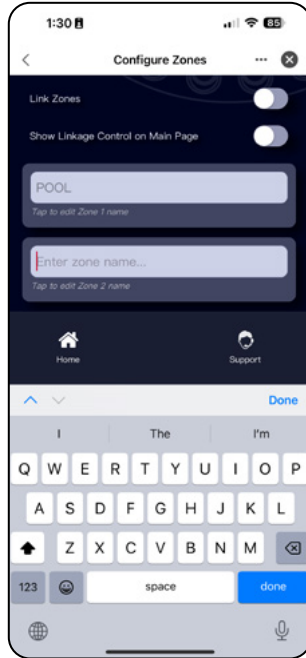

WIRING - EXAMPLE 1

INDEPENDENT WIRING (MAX 4 LIGHTS)

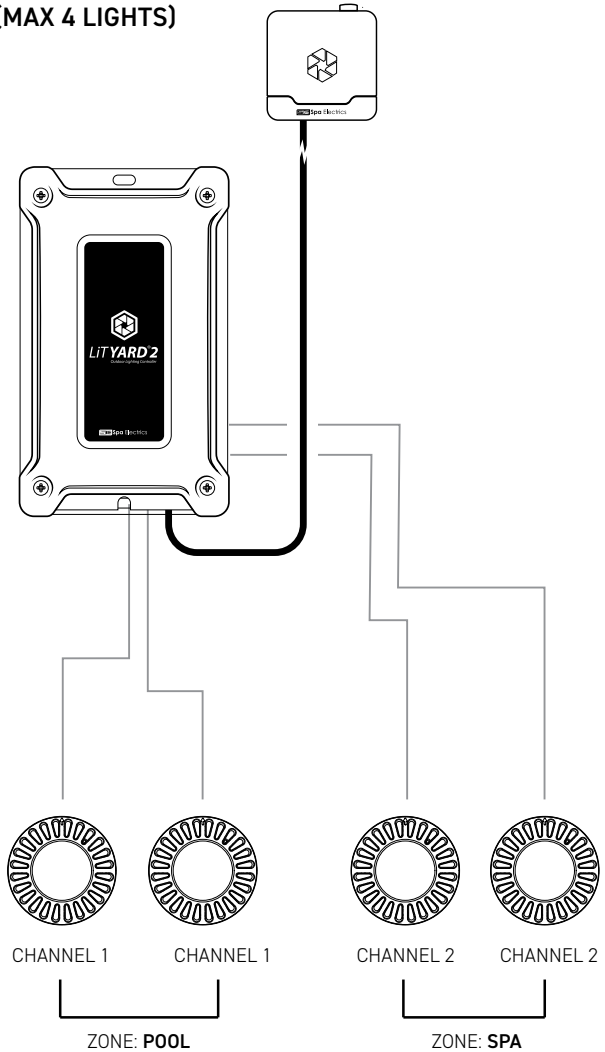

NOTE



POOL & SPA CHANNELS CAN BE CONTROLLED INDEPENDENTLY OR TOGETHER BY LINKING THE ZONES VIA THE APP.

WIRING - EXAMPLE 2

BRANCH WIRING (MAX 6 LIGHTS)

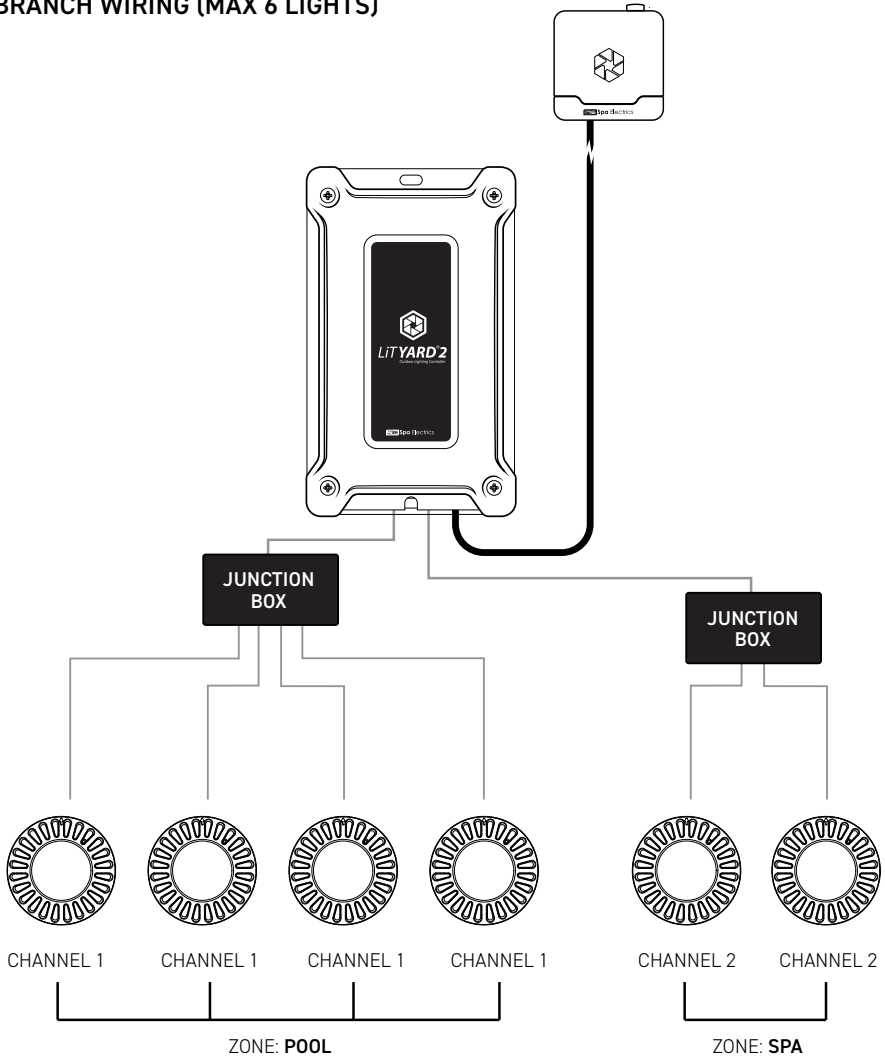

NOTE



POOL & SPA CHANNELS CAN BE CONTROLLED INDEPENDENTLY OR TOGETHER BY LINKING THE ZONES VIA THE APP.

APPENDIX

1. Guest Mode Operation: All functions of the LiT YARD 2 Wi-Fi operate normally, including schedules. You can also receive notifications even in Guest Mode. Limitations of Guest Mode: Access to the LiT YARD 2 Wi-Fi cannot be shared to other Smart Life app users/ accounts. If the Smart Life app is re-installed or Guest Mode is exited, the LiT YARD 2 Wi-Fi will need to be reconfigured and existing settings and schedules will be lost.

TROUBLESHOOTING

CONDITION

CORRECTIVE ACTION

Color selection not functioning correctly/ Wrong colors output

Go to Multi Plus Setup section of this document and follow the instructions

Different lights outputting different colors than each other or color shows not in sync across all lights

Go to Color Shows section of this document and follow step 5 to resynchronise the lights

The LiT YARD 2 Wi-Fi is not connecting to the Smart Device/ Phone.

Refer to FAQs available at: spaelectrics.com/lityard2-wifi-guides-landing

SPECIFICATIONS

Enclosure Size: H27cm x W15cm x D10cm

Enclosure Type: UL Listed Polycarbonate (black)

Primary Conduit Entry: (2) ½"-¾" ports, (2) ¾" ports

Second Conduit Entry: (2) ½"-¾" ports, (2) ¾" ports

Overload Protection: Replaceable 10A blade fuse.

Model	Input 60 Hz.	Secondary Output	
		Lamp Watts (W)*	Voltage (VAC)
LiT YARD 2X	110 VAC	100 Max.	12 / 13.5
LiT YARD 2XP	110 VAC	100 Max.	12 / 13.5

* Any combination of bulbs, any output.

FCC COMPLIANCE STATEMENT

Warning: Changes or modifications not expressly approved by the party responsible for compliance could void the user's authority to operate the equipment. This device complies with part 15 of the FCC rules. Operation is subject to the following two (2) conditions:

- (1) This device may not cause harmful interference, and
- (2) This device must accept any interference received, including interference that may cause undesired operation.

Note: This equipment has been tested and found to comply with the limits for a Class B digital device, pursuant to part 15 of the FCC Rules. These limits are designed to provide reasonable protection against harmful interference in a residential installation. This equipment generates, uses and can radiate radio frequency energy and, if not installed and used in accordance with the instructions, may cause harmful interference to radio communications. However, there is no guarantee that interference will not occur in a particular installation. If this equipment does cause harmful interference to radio or television reception, which can be determined by turning the equipment off and on, the user is encouraged to try to correct the interference by one or more of the following measures:

- **Reorient or relocate the receiving antenna.**
- **Increase the separation between the equipment and receiver.**
- **Connect the equipment into an outlet on a circuit different to that to which the receiver is connected.**
- **Consult the dealer or an experienced radio / TV technician for help.**

The device radiates radio frequency energy at a level below the United States FCC radio frequency exposure limits. Nevertheless, this device should be used in such a manner that the potential for human contact during normal operation is minimized. For body worn operation, this device has been tested and meets FCC RF exposure guidelines when used with accessory that contains no metal. Use of other accessories may not ensure compliance with FCC RF exposure guidelines.

The product contains an RF radiator. Please refer to the label on the product for the relevant FCC ID.

ISED COMPLIANCE STATEMENT

This device complies with ISED Canada license-exempt RSS standard(s). Operation is subject to the following two conditions: (1) this device may not cause interference, and (2) this device must accept any interference, including interference that may cause undesired operation of the device.

The product contains an RF radiator. Please refer to the label on the product for the relevant ISED ID.

Le présent appareil est conforme aux CNR d'ISDE Canada applicables aux appareils radio exempts de licence. L'exploitation est autorisée aux deux conditions suivantes: (1) l'appareil ne doit pas produire de brouillage, et (2) l'appareil doit accepter tout brouillage radioélectrique subi, même si le brouillage est susceptible d'en compromettre le fonctionnement.

Le produit contient un émetteur RF. Veuillez consulter l'étiquette sur le produit pour l'identifiant ISED correspondant.



IMPORTANT NOTE

PLEASE STORE THIS MANUAL IN A SAFE PLACE
FOR FUTURE REFERENCE



 **Spa Electrics[®]**

The underwater lighting specialists

spaelectrics.com

© COPYRIGHT 2025 SPA ELECTRICS INC.
ALL RIGHTS RESERVED

2025 04 14